

**DAELIM**

## OWNER'S MANUAL

 **DAELIM MOTOR CO.,LTD.**  
<http://www.daellmotor.com>

■ HEAD OFFICE (FACTORY)  
#58, SUNG SAN-DONG, CHANG WON, KYUNGNAM, KOREA  
TEL : (82-55) 239-7000 / FAX : (82-2) 467-9997

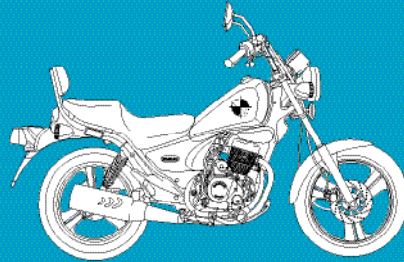

# VS125

OMS3-0512-01E

## IMPORTANT NOTICE

---

### OPERATOR AND PASSENGER

This motorcycle is designed to carry the operator and one passenger.

### ON-ROAD USE

This motorcycle is designed to be used only on the road.

### READ THIS OWNER'S MANUAL CAREFULLY

Pay special attention to statements preceded by the following words:

#### **▲ WARNING**

Indicates a strong possibility of severe personal injury or death if instructions are not followed.

#### **▲ CAUTION**

Indicates a possibility of personal injury or equipment damage if instructions are not followed.

#### **▲ NOTE**

Gives helpful information.

This manual should be considered a permanent part of the motorcycle and should remain with the motorcycle when resold or otherwise transferred to a new owner or operator.

## CONTENTS

<b>SPECIFICATION</b> .....	3	HORN BUTTON .....	15
<b>OPERATION INSTRUCTION</b> .....	4	WINKER SWITCH .....	15
<b>SAFETY PRECAUTIONS</b> .....	4	PASSING LIGHT SWICH .....	15
PRIOR TO STARTING VEHICLE .....	5	<b>EQUIPMENT USAGE</b> .....	16
CORRECT ATTIRE .....	6	STEERING WHEEL LOCK .....	16
OPERATION .....	7	TOOL BOX .....	16
CARGO .....	7	FUEL .....	16
MODIFICATION .....	8	<b>CORRECT DRIVING OPERATION</b> .....	17
ATTACHMENT .....	8	STARTING THE ENGINE .....	18
MUFFLER .....	8	IF ENGINE CANNOT BE STARTED .....	19
<b>PARTS LOCATION</b> .....	9	GEAR SHIFTING .....	19
<b>METER READING AND USAGE</b> .....	12	OPERATION .....	20
METER .....	12	HOW TO USE BRAKE .....	20
TACHOMETER .....	12	PARKING .....	20
FUEL GAUGE .....	12	<b>SELF INSPECTIONS BEFORE OPERATION</b> .....	21
INDICATOR LAMPS .....	13	INSPECTION OF CONCERNED AREA .....	21
<b>SWITCH OPERATION</b> .....	13	BRAKES .....	22
MAIN SWITCH .....	13	TIRES .....	24
HEADLIGHT - POSITION LAMP .....	14	BATTERY .....	25
STARTER BUTTON .....	15	THROTTLE OPERATION .....	26
		CLUTCH .....	27

DRIVE CHAIN .....	28	<b>SAFE DRIVING</b> .....	42
ENGINE OIL LEVEL CHECK .....	28	<b>PREPARATION BEFORE DRIVING</b> .....	42
CHANGING ENGINE OIL .....	29	<b>DRIVING METHOD</b> .....	44
LIGHTS AND WINKER .....	30	DRIVING POSITION .....	44
BACK MIRROR .....	30	PRECAUTION WHEN DRIVING .....	43
LICENSE PLATE .....	30	STARTING .....	45
FRAME AND ENGINE NUMBERS .....	30	<b>TURNING METHOD</b> .....	46
<b>MAINTENANCE</b> .....	31	PRINCIPLE OF TURN .....	46
MAINTENANCE SCHEDULE .....	32	EFFECT OF SPEED .....	46
MAINTENANCE PRECAUTIONS .....	34	3 POSITIONS OF TURNING .....	47
AIR CLEANER ELEMENT .....	35	TURNING METHOD .....	48
IDLE SPEED ADJUSTMENT .....	35	PRECAUTION WHEN TURNING .....	49
WHEEL DISASSEMBLE .....	36	<b>BRAKING METHOD</b> .....	50
SIDE STAND .....	37	BASIC PRINCIPLE OF BRAKE(FRICTION FORCE) .....	50
SPARK PLUG .....	38	RESTRAINT OF BRAKE EFFECT (INERTIA) .....	50
FUSE REPLACEMENT .....	39	BRAKING METHOD .....	51
CABLE RUBBER PART .....	40	COMPARISION OF BRAKING DISTANCE .....	51
CLEANING .....	40	IMPACT WHEN COLLISION .....	51
STORAGE GUIDE .....	41	<b>WIRING DIAGRAM</b> .....	52

## SPECIFICATION

ITEM	DATA	ITEM	DATA
LENGTH × WIDTH × HEIGHT(mm)	2,110 × 795 × 1,160	IGNITION SYSTEM	C.D.I
WHEEL BASE(mm)	1,357	BATTERY CAPACITY	12V 9AH
GROUND CLEARANCE(mm)	167	FUEL CAPACITY( )	10.5
SEAT HEIGHT(mm)	732	TIRE SIZE	FR. 90 / 90 - 18
WEIGHT(kgf)	127		RR. 110 / 90 - 16
PASSENGER	2	SUSPENSION	FR. TELESCOPIC
ENGINE TYPE	AIR COOLED 4 STORKE 4 VALVE		RR. SWING ARM
PISTON DISPLACEMENT(cc)	124.1	BRAKE	FR. HYDRAULIC DISK
BORE AND STROKE(mm)	56.5 × 49.5		RR. DRUM BRAKE
STARTING SYSTEM	START MOTOR / KICK	SPARK PLUG	CR8EH-9
TRANSMISSION TYPE	5 STEPS RETURN	FUSE(A)	15A

## OPERATION INSTRUCTION

This manual describes matters pertaining to correct operation, safe operation and simple maintenance of the vehicle you purchased.

To ensure more comfortable and safer operation, make sure to read this manual carefully prior to operation.

The photographs and drawings shown in this manual may differ from those of actual vehicles due to changes in vehicle specifications and modifications made.

This motorcycle is designed for 2 riders including the operator.

### CAUTION

Do not use polluted gasoline.

Otherwise it cause rust inside the fuel tank, and close the supply of fuel to the carburetor, leading to an improper engine starting or may cause serious damage to an engine.

Do use genuine oil to protect and extend vehicle life.

As far as any defect caused by contaminated gasoline or oil, no warranty shall be assured.

## SAFETY PRECAUTIONS

Careful driving and the wearing of proper attire and safety equipment are the most important factors in the safe operation of the vehicle. Please obey traffic regulations and do not be hurried and careless.

Many new vehicle owners operate their newly purchased vehicles with great care and attention to safety factors. However, after becoming accustomed to the operations are often discarded, which can lead to accidents. Please don't let this happen to you and always approach the operation of your vehicle with the safety considerations needed.

When operating the motorcycle, always keep in mind and obey the notes of precaution printed on the " **Safety Precaution Label** "attached to the motorcycle.

Be sure to wear helmet at all time.

Be sure to put on gloves at all time.

Observe the speed regulations.

Beware of muffler after driving as it is still hot to be burnt. Especially never children touch on it.

For safety, do not change, alteration or modification the vehicle.

Regularly conduct specified maintenance inspections.

<Maintenance Inspection Points>

Brakes, Tires, Oil, Lights, Horn, Instruments

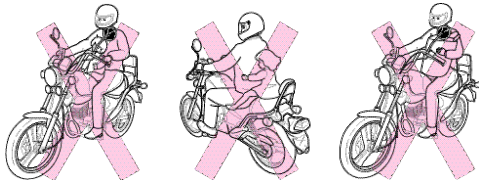

Don't drive with one hand. Hold the handle tightly with both hands.  
When carrying goods, securely fasten them.

**WARNING**

Using one hand or no hands while driving may cause an accident resulting in severe injury.  
For safety, Be prohibited the riding with children as passengers (as above photo)  
Otherwise, this may cause severe injury.

**PRIOR TO STARTING VEHICLE**

Read user's manual carefully.  
Conduct maintenance checks prior to operation.  
Always maintain motorcycle in clean status and carry out specified maintenance checks.  
Make sure to stop engine and stay away from fire when fueling.  
Exhaust gas contains harmful substance such as carbon monoxide. Start engine in well-ventilated places.

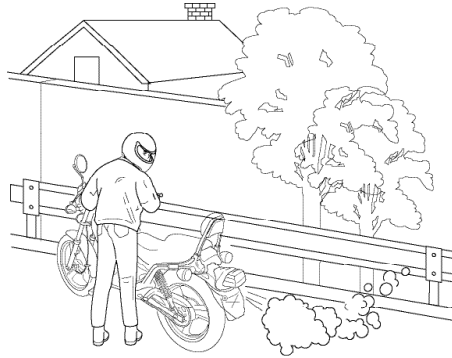

### CORRECT ATTIRE

Always make sure to wear helmet for safety. Wear gloves and safety goggles.

Do not wear uniforms which might hinder operation. It is dangerous if the uniform is caught by brake lever or by the rotating part of drive chain.

Do not wear slippers which might obstruct brake operation or transmission gear operation.

Many automobile/motorcycle accidents happen because the automobile driver does not "see" the motorcyclist.

Make yourself conspicuous to help avoid the accident that wasn't your fault :

- Wear bright or reflective clothing.
- Don't ride in another motorist's "blind spot".

#### **⚠ WARNING**

Not wearing a helmet increases the chance of serious injury or death in a crash.

Be sure you and your passenger always wear a helmet, eye protection and other protective apparel when you ride.

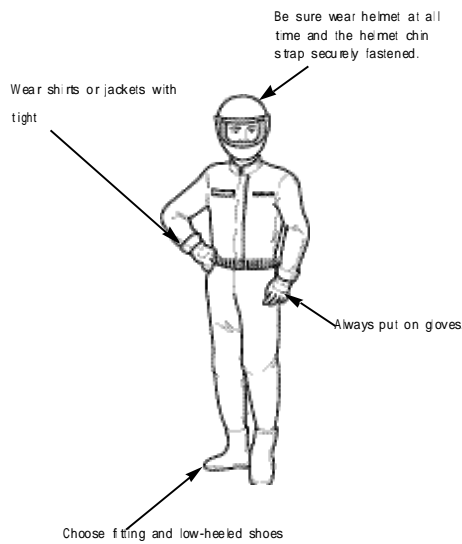



## OPERATION

Operators should naturally fix bodies to keep smooth driving. Please check whether or not you are unnaturally strained and strung up.

Driving pose has a great influence on safe operation. Please always maintain the center of your body in the middle of seat. Especially do not sit at the rear seat because it may lessen the weight of front wheel and cause trembling steering wheel.

A passenger should hold on to the vehicle or the operator with both hands and keep both feet on the pillion step bar.

When wanting to turn, slightly lean to body toward the direction of the turn. It is unsafe if the body is not moved in union with the vehicle.

Curvy roads and poor, unpaved roads constantly change in surface quality. Driving on these roads can be unsafe if certain safety precautions are not followed.

In order to safely drive through these driving conditions, anticipate coming road conditions, slow down to at least half the normal speed, and relax your shoulders and wrists while securely holding the handles.

Driving with one or both hands not holding the handles cause severe injury or death of the driver resulted from the turnover of the vehicle.

## CARGO

When carrying cargo, you must keep in mind that operating the motorcycle, especially when turning, will be different. Make sure not to overload the motorcycle with goods as this can make the motorcycle unstable during operation.

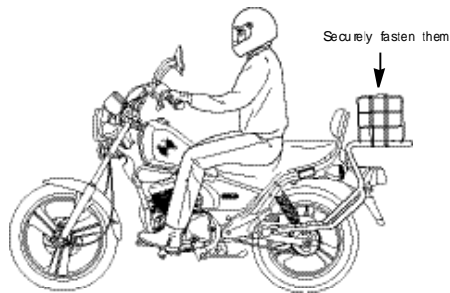

### ATTENTION

Pay attention not to overload goods and fasten it tightly while driving. Overloading or improper loading may cause a crash and severe injury. Do not attach large or heavy items (such as a sleeping bag or tent) to the handle bars or fork. Unstable handling or slow steering response may result.

### MODIFICATION

Modification of vehicle structure or function deteriorates manipulability or causes exhaust noise to become louder shortening the vehicle life. These modifications are not only prohibited by law but also are the acts harmful to other people.

#### CAUTION

Modifications : no warranty shall be assured.

### ATTACHMENT

Except designated attachment by DAELIM MOTOR CO., LTD., don't attach any extra lighting device, otherwise it cause premature discharging of battery.  
Carefully inspect the accessory to make sure it does not obscure any lights, reduce ground clearance and banking angle, or limit suspension travel, steering travel or control operation.  
Do not add electrical equipment that will exceed the motorcycle's electrical system capacity. A blown fuse could cause a dangerous loss of lights or engine power.  
This motorcycle was not designed to pull a sidecar or trailer.  
Handling may be seriously impaired if so equipped.

### MUFFLER

Pay particular attention to fellow passenger so that he or she can prevent getting burnt by the hot muffler during travel.

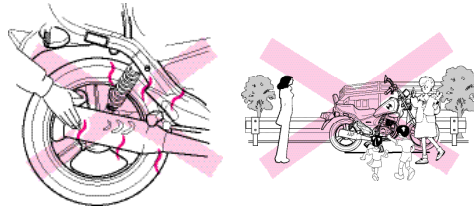

#### CAUTION

Beware of muffler after driving as it is still hot to be burnt. Especially never children touch on it.  
Pay attention to park where pedestrian zone.  
If haystack or vinyl is stuck to the muffler, it might be fired

## PARTS LOCATION

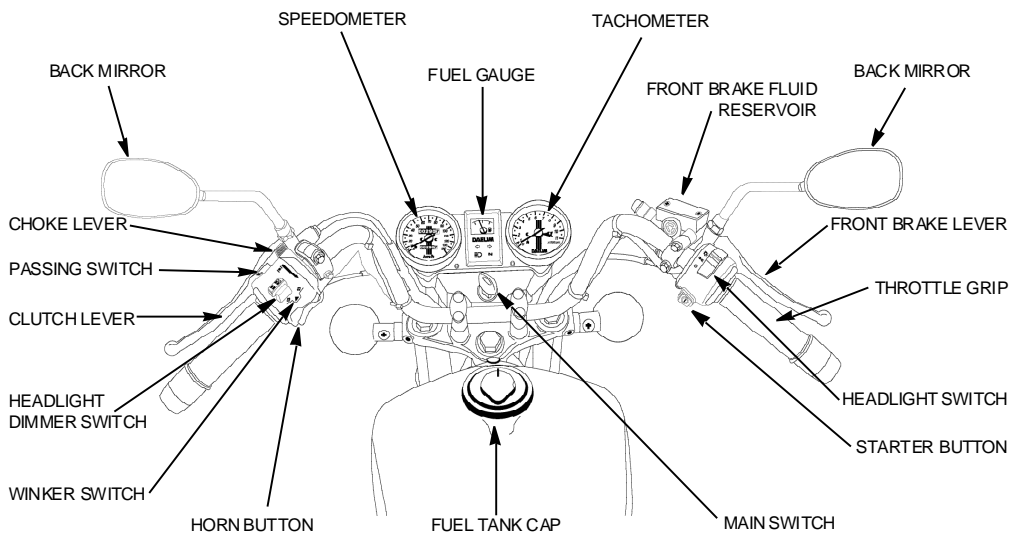

### PARTS LOCATION

---

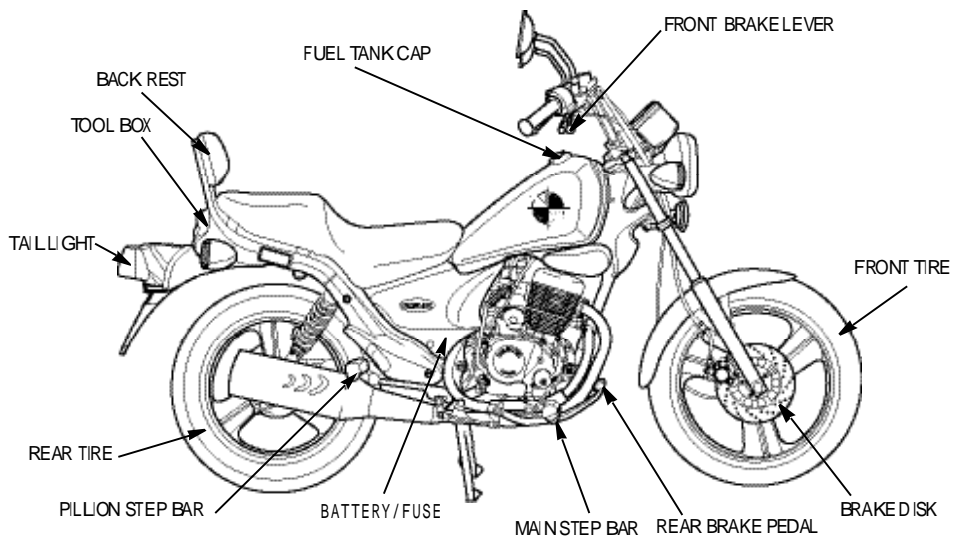

## PARTS LOCATION

---

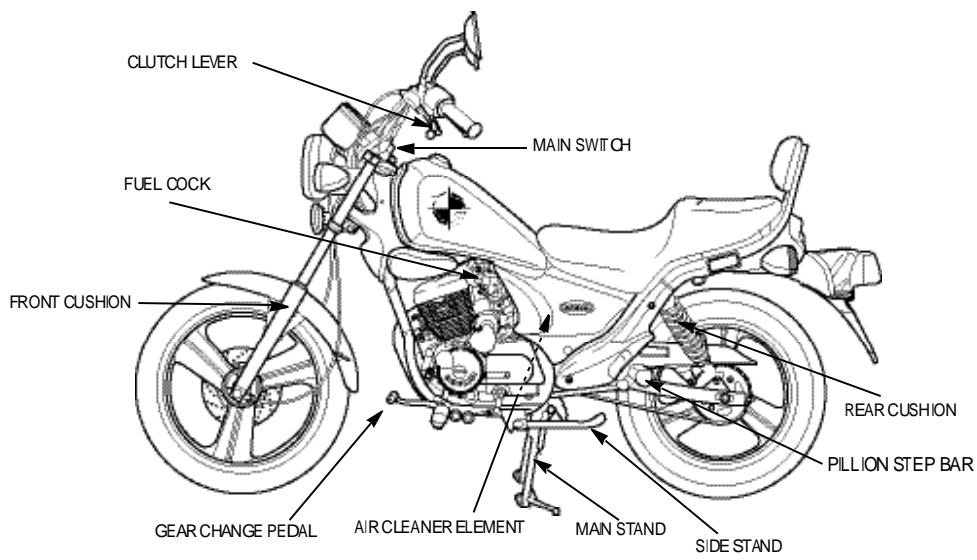

## METER READING AND USAGE

### METERS

#### <SPEEDOMETER>

Indicates speed in km/h during travel. Maintain legal speed limits to ensure safe operation.

#### <ODOMETER>

Indicates total operating distance in km.

#### <TRIP METER>

Indicates travel distance from the point the meter is reset to "0". To reset meter, turn the trip meter knob to the direction of arrow.

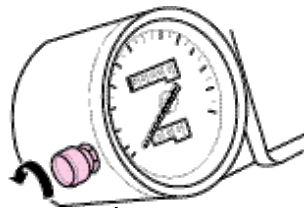
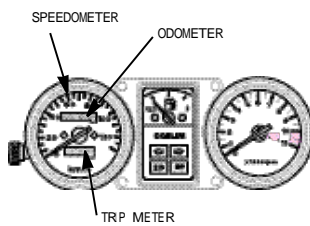

TRIP METER RESET KNOB

### TACHOMETER

Indicates engine revolutions. (rpm)

#### CAUTION

Make sure, during travel, the tachometer needle cannot be entered danger zone (red zone) due to excessive engine running.

Pay particular attention because idle engine running or abrupt acceleration in the 1st or 2nd gear may cause the tachometer needle to be in the danger zone (red zone).

Danger zone means the engine revolution limit and, if engine is run beyond this danger limit, engine will be damaged.

### FUEL GAUGE

Indicates amount of gasoline in fuel tank. (The fuel gauge needle always indicates gasoline level regardless of whether main switch is in "OFF" position or in "ON" position.) If needle is within "E" mark, immediately fill gasoline. Balance at this time is approximately 1.0 litres.

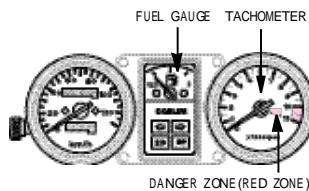

**INDICATOR LAMPS**

Winker blinks when turn signal lamp is blinking.

**<HEADLIGHT HIGH-BEAM INDICATOR>**  
Turned on when the headlight is in high-beam position.

**<NEUTRAL INDICATOR>**  
Turned on when the main switch is in "ON" position and gear is in neutral position.

**<WINKER INDICATOR>**  
If main switch is turned "ON" and winker is activated, the winker located in the direction of turning is turned "on"

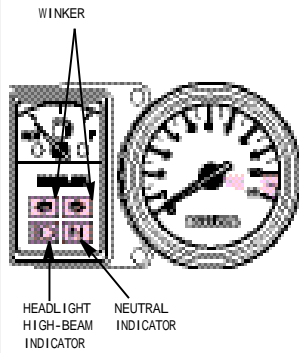

**SWITCH OPERATION**

**MAIN SWITCH**

Main switch is used to turn on or turn off engine

Key position	Function	Key removal
ON	Starts engine. Power is supplied to electrical circuits	Key cannot be removed
OFF	Stops engine. Cuts off all electrical circuits.	Can be removed
LOCK	Cut off all electrical circuits and steering wheel is locked	Can be removed

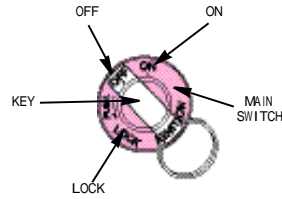

**SWITCH OPERATION**

**CAUTION**

Do not operate main switch key while driving. If the main switch key is placed on " Off " or " Lock " position, all electrical system will not function.  
Do not operate the main switch key during travel as it might cause unexpected accidents. If it is necessary to remove the main switch key, stop the vehicle first prior to removing.  
Prior to dismounting from the vehicle, make sure to lock the steering wheel and remove key.

**HEADLIGHT · POSITION LAMP**

**<TURNING ON HEADLIGHT>**  
Put main switch key in "ON" position and turn on headlight switch.

Switch position	Funcation
H	Headlight and tali/stop light turned on
P	Position lamp and taillight turned on.
⊙	Light turned off

When you travel after sunset, put headlight in low-beam. This lets approaching vehicles know of your position and is helpful for safe driving.

**<HEADLIGHT HIGH OR LOW BEAM OPERATION>**

High beam or low beam can be operated by the use of high/low beam switch.  
HI···· Headlight placed on high beam  
LO···· Headlight placed on low beam

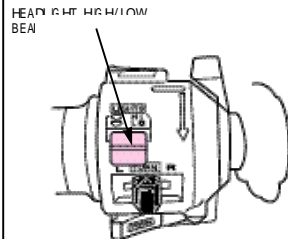
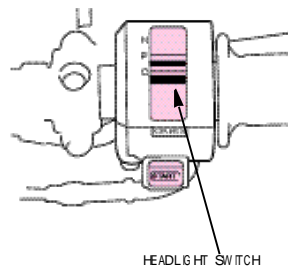



**STARTER BUTTON**

If you press this button, starter motor runs and engine is started.

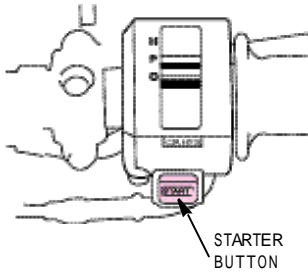
**CAUTION**

Do not press starter button repeatedly because it consumes great amount of power causing battery to be exhausted sooner.

**HORN BUTTON**

If horn button is pressed when main switch is in "ON" position, horn is sounded

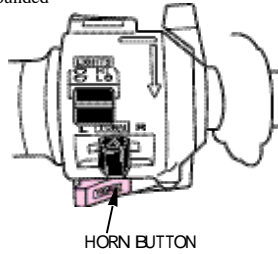
**WINKER SWITCH**

Use winker switch when you turn to left or right

**<HOW TO USE>**

If this switch is turned on when the main switch is in "ON" status, winker is brinking. To release winker operation, return winker switch to its original position.  
R .... Turn to right  
L .... Turn to left

**PASSING LIGHT SWITCH**

This switch is used to let other operators know your intention of passing other vehicles.

**<HOW TO USE>**

Press passing light switch

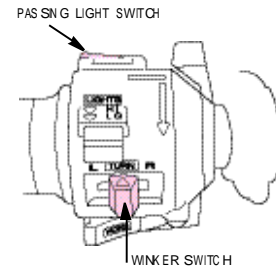
**CAUTION**

If the headlight is placed on high-beam, this switch will not operate.

**EQUIPMENT USAGE****STEERING WHEEL LOCK**

To prevent from being theft, lock steering wheel when parking the vehicle.

**<HOW TO LOCK>**

Turn the steering wheel to left completely.

Insert main switch key.

Turn the key 180 to the right.

If the steering wheel cannot be locked, move the steering wheel slightly to right and left while turning the key.

Remove the key.

**<HOW TO RELEASE>**

Release in the reverse order of locking

**MAIN SWITCH KEY****CAUTION**

To make sure steering wheel is locked properly, lightly turn steering wheel to left and right and verify lock.

Park the vehicle in places free of traffic.

Prior to operation, turn the steering wheel to left and right to verify if turning angles of left and right are equal.

**TOOL BOX**

Tool box is behind the seat. Safeguard owners manual or maintenance note book can be kept in this box.

**<HOW TO USE>**

Use main switch key to open or close the tool box cover.

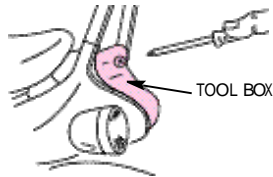
**INSPECTION BEFORE STARTING****FUEL CHECK**

Check gasoline to see if the gasoline level is sufficient to operate vehicle to destinations.

**<REFUELING>**

Open key cover ; insert main switch key ; turn key to right and fuel tank cap is opened.

Fill gasoline up the bottom of level plate located at the lower side of tank mouth.

Push the tank cap correctly with hands and remove the main switch key. (If the fuel tank cap is not locked, the main switch key will not be removed)

**CAUTION**

Make sure to stop engine and stay away from fire when fueling.

If gasoline is filled above the level plate bottom, gasoline may overflow.

### FUEL COCK

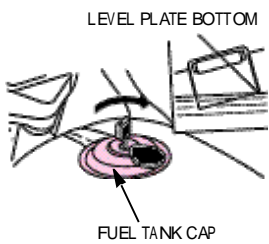

#### <FUEL COCK>

The fuel cock lever arrow indicates operating position.

- ON...Gasoline is supplied. Set fuel cock to this position when starting engine
- OFF...Fuel is not supplied. Set to this position except when the vehicle is operated
- RES...Indicates reserve fuel. If fuel runs out while driving with the fuel cock lever placed in the "ON" position,

put the lever in "RES" position and refuel immediately. After refueling return the lever to "ON" position.

**Reserve fuel capacity:  
Approximately 1.0 liter**

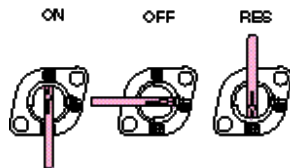

#### CAUTION

If the lever is not turned to "ON" reserve, fuel will run out during travel and vehicle cannot be operated.

### CORRECT DRIVING OPERATION

Make sure to check the oil, gasoline, etc., before starting the engine. Please ensure that the main stand and the side stand are in a up-position when starting the engine. Make sure that the front wheel is locked when starting the engine. Drive with care for both safety reasons and longer vehicle life. For 1 month (or 1,000km) after purchasing the vehicle, drive moderately avoiding fast starts and fast acceleration.

#### CAUTION

Keep holding the brake lever at start-up in order to prevent the vehicle from springing out and causing injury. Do not operate the throttle while the main stand is set. Otherwise, the rear wheel may touch with the ground and cause injury due to a sudden movement of the vehicle.

## STARTING THE ENGINE

### <WHEN ENGINE IS COLD(WINTER)>

1. Make sure fuel cock lever is in "ON" position.
2. Turn on main switch.
3. Put gear in neutral.  
(Verify this with neutral indicator lamp)
4. Open choke lever all the way.
5. Close throttle grip and press starter button.
6. Once engine is started, pull and release throttle grip repeatedly to run engine idle until engine is heated, and close choke lever completely. If engine warming up takes time, run engine idle with the choke lever slightly closed.
7. Verify side stand is positively in original position and start slowly.

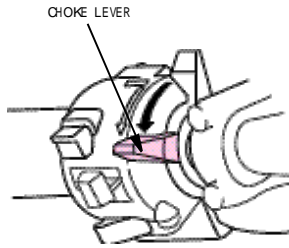

### <WHEN ENGINE IS HOT(SUMMER)>

1. Make sure fuel cock lever is in "ON" position.
2. Turn on main switch.
3. Put gear in neutral.(Verify this with neutral indicator lamp)

4. Close throttle grip and press starter button. (If engine is not started with 1-2 times of trial, verify fuel cock lever is in "ON" position)
5. If engine is not started with throttle grip closed, open throttle grip approximately 1/8 to 1/4 and press starter button.
6. Verify side stand is positively in original position and start slowly.

If engine cannot be started, refer to next page for more details.

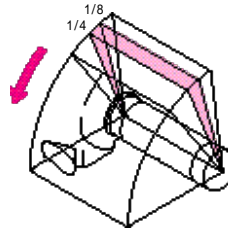

**CAUTION**

Exhaust gas contains harmful substance such as carbon monoxide. Start engine in well-ventilated places.

If engine is not started within 3 seconds after starter button is pressed, wait for approximately 10 seconds and retry. This is to recover battery voltage.

Do not run engine idle unreasonably. This not only wastes fuel but also adversely affects engine.

If starter button is pressed without disengaging clutch, motorcycle may bring out to fall. Make sure gear is in neutral position or disengage clutch prior to starting engine.

**IF ENGINE CANNOT BE STARTED**

If engine cannot be started or vehicle does not move, check the followings.

Is there fuel in fuel tank?

Are you operating in accordance with the instructions given in user's manual?

Is fuse not cut?

Is starter motor running?

If starter motor is not running due to battery consumption, try starting motor by using kick start technique.

**GEAR SHIFTING**

Gear is shifted in 5-shift return system as shown on the right side drawing.

Close throttle grip and hold clutch lever perfectly, and shift gear.

Touch pedal lightly with foot and shift gear perfectly until you hear "Click" at the pedal. If you apply excessive force when shifting gear, transmission may be damaged.

**<GEAR DOWN OPERATION>**

If you gear down when you need to drastically accelerate speed such as when you are passing another vehicle, speed can be accelerated. If you ride too fast, it adversely affects engine because engine revolution is excessive.

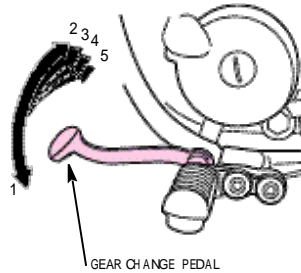

**OPERATION**

Make sure side stand is in original position prior to starting vehicle. If side stand moves unsatisfactorily, check lubrication state on side stand joint. Shift gear adequately according to vehicle speed. To save fuel and maintain optimum vehicle life, do not accelerate or decelerate speed abruptly.

**CAUTION**  
Start carefully as slow as possible. If you hear abnormal noise during travel, contact authorized maintenance shop immediately for inspection and necessary action. Maintain legal speed limits.

**<BREAK-IN OPERATION>**

Maintain engine revolution at a level less than 6,000rpm for first 1,000km to break in vehicle. If vehicle is broken in as above, the life span of equipment is prolonged.

**HOW TO USE BRAKE**

Apply brakes on front wheel and rear wheel simultaneously. Avoid unnecessary abrupt braking.

**CAUTION**  
If you apply brakes only on front wheel or rear wheel, vehicle may slide off sideways and fall. If you apply brakes abruptly during travel in rain or on wet road, tires slide off and may cause accidents. Reduce speed and apply brake cautiously. Avoid repeated brake operation as it may cause brake temperature to rise, leading to braking effect deterioration.

**<ENGINE BRAKE>**

If you turn throttle grip in reverse, engine brake functions and, if you need stronger braking, shift gear down from 4th to 3rd and so forth. When you travel on a long descent or on a sharp descent, use intermittent braking technique and engine brake simultaneously.

**CAUTION**  
A abrupt downshift may cause the shake of rear parts.

**PARKING**

Put gear in neutral and put main switch to "OFF" position to stop engine. Put fuel cock to "OFF" position. Put vehicle on main stand and park on level ground in places free of traffic. If you park vehicle on an uneven ground, vehicle may fall.

**CAUTION**  
Select a safe place free of traffic and park vehicle. Muffler is hot. Park vehicle in places where there is no danger for people to contact with vehicle.

**<PARKING WHEN SIDE STAND IS USED>**

Stop vehicle on level ground and park with the steering wheel turned to left. If the vehicle is parked in the following way, vehicle may fall to side.

If the vehicle is parked with the steering wheel turned to right, or if parked on a slope, sandy places, uneven ground or soft ground, vehicle may fall.

If is necessary to park in an unstable ground under unavoidable situation, take sufficient safety measures to prevent vehicle from falling or moving.



### SELF INSPECTIONS BEFORE OPERATION

Self inspect the motorcycle and have regular maintenance inspections for increased safety and the prevention of accidents.

Self inspections before operation should be performed on a daily basis prior to operating the vehicle.

Inspections of areas of concern.

Fuel check

Brake inspection

Tire inspection

Battery acid level inspection

Throttle grip Inspection

Clutch inspection.

Drive chain inspection.

Engine oil inspection.

Lights and winker inspection.

Back mirror inspection.

License plate inspection.

### CAUTION

Observe safety rules when conducting inspections.

Exhaust gas contains harmful substance such as carbon monoxide. Do not carry out inspections on vehicle in closed places, or in poorly ventilated places, with engine running.

Conduct inspections on flat, solid ground with the stand erected.

Be careful of burns when conducting inspections immediately after engine is stopped because the engine and muffler are hot. Stop engine and remove the key prior to the vehicle maintenance service.

If you are unable to correct trouble even after you make adjustment or correction, contact authorized maintenance shops, dealers or designated repair shops for necessary inspection and repairs.

### INSPECTION OF CONCERNED AREA

Check areas which caused for concern when last operating the vehicle.



**BRAKE CHECK**

**FRONT WHEEL**

**<BRAKE OIL INSPECTION>**

Put main stand in upright position on a flat ground and operate steel wheel, and check fluid when the top of master cylinder cap is level.

Check fluid level to see if it is below lower level.

If fluid significantly is in low level, it may indicate fluid leakage on brake system. If this happens, check fluid leaks or brake system. If this happens, check fluid leaks or damage on system and inspect joints and clamps for looseness.

In addition, check hose and pipe protective part to see if they make contact with other parts when you make left or right turn due to vibration during travel.

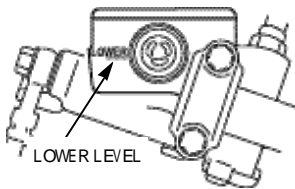

**CAUTION**  
 Brake is an important part which protects your life. Make sure to inspect brake prior to daily use.

**REPLENISHING BRAKE OIL**

Move steering wheel and set the top of reserve tank level.

Clean dust and other foreign matter from around master cylinder and take caution not to allow foreign matter to fall inside master cylinder

Open cap screw and remove diaphragm. Replenish recommended brake fluid to upper level inside master cylinder. Tighten cap accurately, paying attention to the direction of diaphragm assembling, and avoid ingress of foreign matter.

**RECOMMENDED BRAKE IS DOT 3-4**

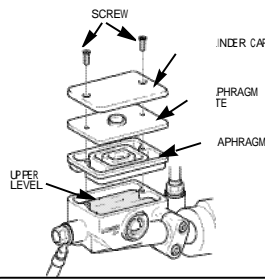

**CAUTION**  
 Do not fill brake fluid above upper level as it may cause brake fluid to leak outside. Exercise full caution, when replenishing brake fluid, not to allow dust or water to mix inside master cylinder. If the amount of brake fluid decreases considerably, it is an indication of brake system trouble. To prevent occurrence of chemical change, do not use brake fluid of different manufacturer. Do not let brake fluid contact vehicle parts because it causes damage to painted parts.



### BRAKE INSPECTION

#### FRONT WHEEL

##### <BRAKE PAD INSPECTION>

Operate brake and, if the brake pad wear limit line reaches the brake disc side, it indicates the pad has reached wear limit.

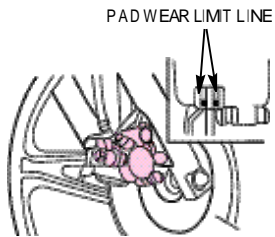

#### REAR WHEEL

Push the brake pedal with hands for resistance and check if the pedal movement is appropriate.

If brake pedal movement is inappropriate, adjust the pedal free play using the rear wheel brake adjuster nut.

To adjust pedal free play, turn adjuster nut.

After adjustment, push the brake pedal with hands until you feel resistance and check to see if the pedal free play is within prescribed range.

##### BRAKE PEDAL FREE PLAY : 20-30mm

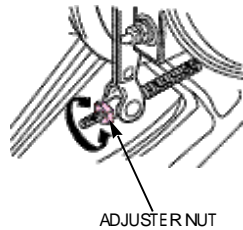
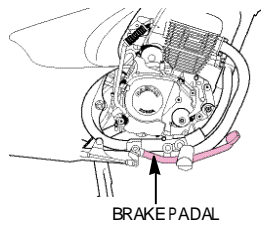

##### <BRAKE SHOE INSPECTION>

Push brake pedal completely and, if the brake arm arrow and the " " on brake panel match each other, it indicates brake shoe has reached its life limit.

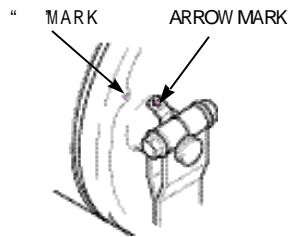

**NOTE**  
In case brake pad or shoe reaches the wear limit line, replace it immediately.  
Worn brake pad can cause an accident due to lack of power

**TIRES**

**<TIRE PRESSURE CHECK>**

Check for an appropriate level of air pressure by examining how the tire sits on the ground. If you notice any abnormalities in the shape of the tire with regard to the area contacting the ground, use a tire gauge to check tire pressure and adjust the tire pressure to the appropriate level.

**<TIRE PRESSURE>**

SIZE	FRONT	90/90-18	
	REAR	110/90-16	
TIRE PRESSURE (kg/cm <sup>2</sup> )	1 PERSON RIDING	FRONT	1.75
		REAR	2.00
	2 PERSON RIDING	FRONT	1.75
		REAR	2.25

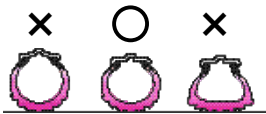

**<CRACKS/DAMAGE>**

Check tire tread and sides for cracks and damage.

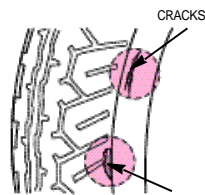

**<ABNORMAL WEAR>**

Check tire tread for signs of abnormal wear.

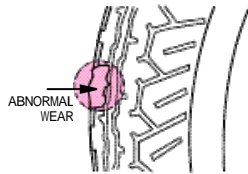

**<FOREIGN MATTER>**

Check tire tread and sides for nails, rocks, etc. That might have become wedged in the tire.

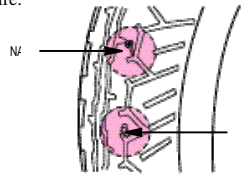

**<TREAD DEPTH>**

Check the wear indicator(wear limit marking) to see if there is an insufficient amount of tread remaining.

If the indicators are visible, replace tire with a new one.

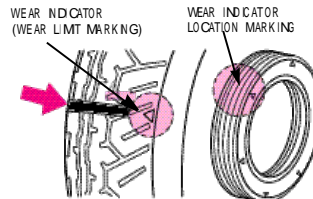

**ATTENTION**

If air pressure is inadequate or if there are cracks, damage or abnormal wear on tires, it may cause trembling steering wheel and flat tire.

Insufficient air pressure may cause the heavy steering wheel marking handling difficult, fuel over consumption and the excessive wear of tire outer area and excessive air pressure may cause easier wheel handling and lower fuel consumption. But it may also cause the excessive wear of tire center area.

This vehicle is equipped with tubeless tires. If you have flat tires, please contact authorised maintenance shops for inspection.

**BATTERY ACID LEVEL CHECK**

Remove the four flange bolts, and take off the right lower cover.

Place vehicle in upright position and check battery acid of each cell to see if it is between upper and lower level. If the battery acid is near lower level, replenish distilled water.

Refer to page 34 for battery acid replenishing.

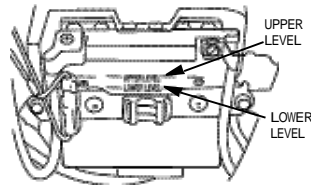
**BATTERY ACID REPLENISHING**

If the battery acid is insufficient, replenish distilled water in the following sequence.

Loosen the bolt and open the battery band.

Remove the battery breather tube from the battery.

Remove the negative pole side cord first and the positive pole side cord next.

Remove the battery and open the battery cap. Fill distilled water to near upper level.

Tighten the battery cap accurately to the vehicle and install battery. Make sure, at this time, that side cord is connected first, followed by side cord.

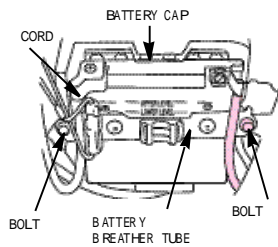

#### CAUTION

Stay away from when handling battery.  
When battery holder is opened, do not allow the side cord to contact metal part.

After installing battery, verify the breather tube has been accurately assembled to elbow. If the breather tube is removed, the battery acid causes damage to adjacent parts. If the tube is bent and clogged, the battery internal pressure rises and battery case may be damaged. Follow instructions on the label attached to vehicle for correct checking procedure.

If excessive amount of distilled water put in, it overflows and causes corrosion of affected part.

Battery acid contains thin sulfuric acid. Prevent its contact with eyes or skin as it causes damage if contacted. If battery acid gets on part of your body, immediately flush the affected area with clean for longer than 5 minutes, and consult medical doctor for necessary treatment.

Make sure cords are not twisted or inserted when assembling battery to battery holder.

#### THROTTLE OPERATION

Check for smooth rotation of the throttle grip from the fully open to the fully closed position at both full steering positions.

Measure the throttle grip free play at the throttle grip flange.

The standard free play should be approx.

: **2-6 mm**

To adjust the free play, turn the adjuster.

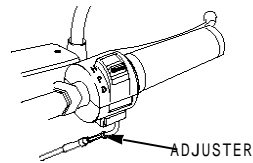

#### CAUTION

Operating the motorcycle with an inadequate throttle grip free play can be hazardous. Inadequate throttle grip free play can cause engine speed to rise suddenly when you turn the handlebars.

## CLUTCH

### <LEVER FREE PLAY INSPECTION>

Pull clutch lever until you feel resistance, and using a graduated ruler, check the lever end free play to verify it is within prescribed level.

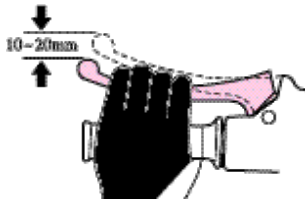

### <CLUTCH OPERATION>

When engine is idling, pull clutch lever all the way and see if there is abnormal noise or if you feel unusual heaviness. Slowly release clutch lever and start. Check at this time to see if clutch is engaged smoothly without slipping.

### <CLUTCH LEVER ADJUSTMENT>

Adjust lever free play by using the clutch cable's clutch lever side or clutch side adjuster.

Clutch side lock nut and adjust with adjuster.

For fine adjustment, loosen the clutch lever side lock nut and turn adjuster.

After adjustment is completed, pull clutch lever with hands until you feel resistance and verify the lever end free play is within prescribed level.

**CLUTCH LEVER FREE PLAY:**  
10-20mm

#### ATTENTION

Upon completion of adjustment, start engine and verify gear change pedal is operating smoothly.

### MAJOR ADJUSTMENT

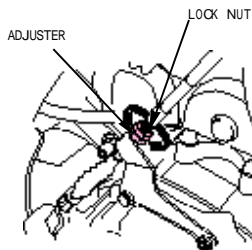

### FINE ADJUSTMENT

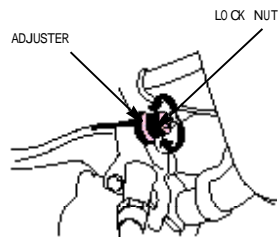

**DRIVE CHAIN INSPECTION**

Put vehicle in upright position on main stand and move the center of front and rear sprocket up and down with hands to determine if the chain free play is within prescribed range.

**optima free play : 15~25mm**

If free play is great, loosen axle and put the left and right lock nuts, and make necessary adjustment by turning adjuster nut.

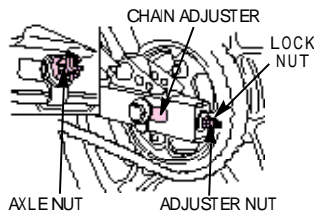

**<DRIVE CHAIN INSPECTION>**

Check drive chain tension and sprocket wear and damage. If roller is damaged or pin is loose, replace chain.

If sprocket is worn or damaged, replace. Check chain to determine if it is dry, or if it is smeared with dust, waste material, soil or sand. Clean dust and other foreign matter, and apply lubricants on clean chain.

**CAUTION**  
 Make sure the right and left chain adjuster graduation are set in the same position.  
 Tighten an axle nut.  
 Tightening torque :7.0Kg-m  
 Tighten an adjuster nut, and tighten lock nut.



**CAUTION**  
 After adjusting chain, check the rear brake pedal operation.

**ENGINE OIL LEVEL CHECK**

Put vehicle in upright position on flat ground and check engine oil level and degree of pollution.

Run engine idle for approximately 2~3 minutes on flat ground and stop engine. After approximately 2~3 minutes, put vehicle in upright position and check engine oil and verify the oil level is between the upper and lower level of oil level gauge.

Insert oil level gauge, without locking, and check oil level after removing oil gauge.

If the oil level is near lower level, replenish oil to upper level.

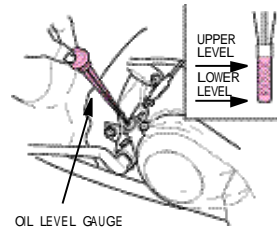

OIL LEVEL GAUGE

### CHANGING ENGINE OIL

If engine oil is polluted, it seriously affects the engine life span. Maintain appropriate level of oil, use correct type of oil and observe oil exchange period.

Stand vehicle on the main stand on level ground and run engine idle (warm up) for approximately 2-3 minutes.

Stop engine and place a container under the engine.

Remove oil level gauge and drain bolt.

Clean oil filter screen.

Check the condition of oil filter screen seal rubber and, o-ring.

Close oil filter screen, spring, and oil drain bolt, and replenish oil up to the upper level of the oil level gauge.

#### OIL CAPACITY: 1.0

#### CAUTION

Be sure to keep oil away from children and pets. Dispose of used oil properly.

#### <RECOMMENDED OIL>

Do use genuine oil to protect and extend vehicle life

As far as any defect caused by contaminated gasoline or oil, no warranty shall be assured.



GRADE(SE, SF, SH)

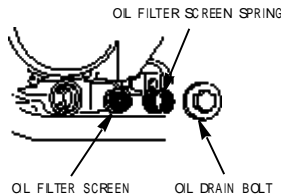

#### CAUTION

If you change engine oil immediately after engine is stopped, be careful of burns because the engine, muffler and engine oil are still hot.

Exercise caution not to allow dust or other foreign matter to flow in when refilling engine oil. If oil overflows, wipe off oil clean.

If oil level is lower or higher than prescribed level, engine is adversely affected.

Do not mix oil with those of different manufacturers or grade, or do not use low-quality oil as it may cause deterioration of oil, leading to accidents.

Clean the oil filter screen with fresh cleaning oil every 4,000km.

Be careful not to lose the oil filter screen spring when assembling the oil drain bolts.

### LIGHTS AND WINKER

#### [HEAD LIGHT, TAIL LIGHT]

Start the engine and make sure the lights turn on. Also check to see if the lights are damaged or if there is dirt on them.

#### [BRAKE LIGHT CHECK]

Turn the main switch to ON. While separately operating the front and rear brakes, check to see if the brake light turns on. Also check to see if there is any damage to the lens or if there is dirt on the brake light.

#### [WINKER CHECK]

Turn the main switch to ON. Check to see if all the winker in the front and rear of the vehicle (including left and right sides) are flashing properly. At the same time, check to make sure that the automatic sound signal of the winker is working. Check also to see if any of the lens are damaged or dirty.

### BACK MIRROR

Sit squarely on the seat and check to see if you have a good view behind the vehicle by looking at the rear view mirrors. Also check for dirt and damage on the rear view mirrors.

### LICENSE PLATE

Check to see if there is any dirt or damage to the license plate. Also check to see if the license plate is firmly secured to the vehicle.

### FRAME AND ENGINE NUMBERS

The frame and engine numbers are needed when registering motorcycle or when ordering parts.

Frame number is stamped on the right side of steering head.

Engine number is stamped on left crank case.

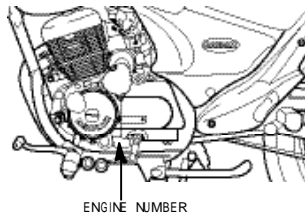
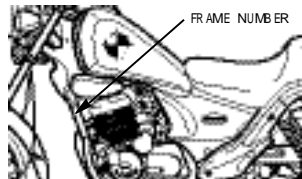





---

## MAINTENANCE

The Required Maintenance Schedule specifies how often you should have your motorcycle served, and what things need attention. It is essential that your motorcycle be served as scheduled to retain its high level of safety, dependability, and emission control performance.

These instructions are based on the assumption that the motorcycle will be used exclusively for its designed purpose. Sustained high speed operation, or operation in unusually wet or dusty conditions, will require more frequent service than specified in the MAINTENANCE SCHEDULE.

Consult your authorized Daelim dealer for recommendations applicable to your individual needs and use.



**MAINTENANCE SCHEDULE**

Perform the Self Inspections Before Operation at each scheduled maintenance period.

I: INSPECT AND, CLEAN, ADJUST, LUBRICATE OR REPLACE IF NECESSARY

R: REPLACE L: LUBRICATE C: CLEAN

ITEM	FREQUENCY	ODOMETER READING(NOTE1)						REMARK
		× 1,000Km	1	4	8	12	16	
		MONTH		6	12	18	24	
FUEL LINE				I	I	I	I	
FUEL FILTER				R	R	R	R	
THROTTLE OPERATION			I	I	I	I	I	
CARBURETOR CHOKE			I	I	I	I	I	
AIR CLEANER ELEMENT				R	R	R	R	NOTE( 2)
SPARK PLUG				I	R	I	R	
VALVE CLEARANCE				I	I	I	I	
CARBURETOR IDLE			I	I	I	I	I	
ENGINE OIL			R	R	R	R	R	
ENGINE OIL FILTER			R	R	R	R	R	
DRIVE CHAIN		Every 1,000 : I and L						
BATTERY ACID				I	I	I	I	

ITEM	FREQUENCY	ODOMETER READING(NOTE 1)						REMARK
		×1,000Km	1	4	8	12	16	
		MONTH	1	6	12	18	24	
BRAKE FLUID			I	I	I	I	R	NOTE( 3)
BRAKE SHOE / PAD WEAR			I	I	I	I	I	
BRAKE SYSTEM			I	I	I	I	I	
BRAKE STOP SWITCH			I	I	I	I	I	
HEADLIGHT ADJUSTMENT			I	I	I	I	I	
SUSPENSION					I		I	
CLUTCH			I	I	I	I	I	
SIDE STAND				I	I	I	I	
BOLTS, NUTS, FASTENERS			I		I		I	
WHEELS / TIRES			I	I	I	I	I	
STEERING HANDLE BEARING			I	I	I	I	I	

If you do not have the appropriate tools or information to conduct maintenance, or if you feel you are not capable to perform maintenance on this vehicle, contact authorized dealers or repair shops for maintenance and repairs.  
 To ensure safety, inspections and maintenance of these parts must be carried out by dealers, or repair centers.

- NOTES :** (1) At higher odometer readings, repeat at the frequency interval established here.  
 (2) Service more frequently when riding in unusually wet or dusty areas.  
 (3) Replace every 2 years, or at indicated odometer interval, whichever comes first. Replacement requires mechanical skill.

### MAINTENANCE PRECAUTIONS

The following is an explanation of correct inspection methods, cleaning and parts replacing. Please always refer to this section when wanting to inspect or repair your vehicle.

#### ⚠ WARNING

If your motorcycle is overturned or involved in a collision, inspect control levers, cables, brake hoses, calipers, accessories, and other vital parts for damage. Do not ride the motorcycle if damage impairs safe operation. Have your authorized Daelim dealer inspect the major components, including frame, suspension and steering parts, for misalignment and damage that you may not be able to detect.

Use new, genuine Daelim parts or their equivalent for maintenance and repair. Parts which are not of equivalent quality may impair the safety of your motorcycle and the effective operation of the emission control systems.

#### ⚠ CAUTION

Always observe safety rules when performing maintenance on the vehicle.

Choose a flat surface and make sure the main stand is in a secure down position.

Use correct tools.

Conduct engine maintenance with the engine key out of the ignition.

Be careful around the engine and muffler when performing maintenance as these areas can become extremely hot.

After self maintenance, the waste material must be packed in the specified container and entrusted disposal to the authorized disposal company.

Exhaust gas contains harmful substance such as carbon monoxide.

Do not carry out inspections on vehicle in closed place, or in poorly ventilated places, with engine running.

### AIR CLEANER ELEMENT

#### <INSPECTION>

This vehicle is equipped with viscous type air cleaner element containing oil and the element cannot be cleaned.

Replace element after each operation of 4,000km.

#### <DISASSEMBLING>

Loosen four screw and remove air cleaner case cover.

Loosen four washer screw and air cleaner element.

#### <ASSEMBLING>

Assemble in the opposite order of disassembling.

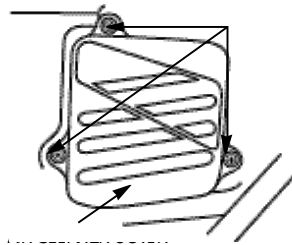

AIR CLEANER  
ELEMENT

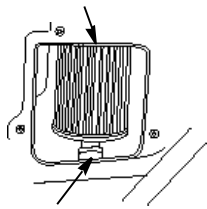

SET SPRNG

**WARNING**

If air cleaner element is inadequately assembled, dust and other foreign matters are absorbed directly into the element, inducing cylinder wear or output deterioration and adversely affecting engine durability. Assemble correctly. When cleaning vehicle, be careful not to allow water to get into air cleaner. If water gets inside air cleaner, it causes inefficient engine starting.

**IDLE SPEED ADJUSTMENT**

Put vehicle in upright position on a flat ground.

Start engine and let it run idle for a few minutes.

Using the throttle stop screw, adjust idling to prescribed level.

**IDLING REVOLUTION: 1,400 ± 100rpm**

Tighten up pilot screw and loose backward 1/4 to open.

Operate throttle lever lightly and verify there is no change in the number of idle running. If there is a change, repeat the process described in paragraph and

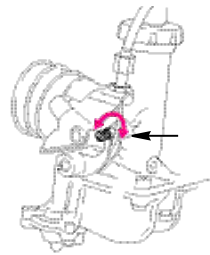



### WHEEL DISASSEMBLE

#### [FRONT WHEEL]

Put vehicle in upright position on the main stand on level ground and let front wheel lifted in the air  
Loosen oval head screw and remove speedmeter cable  
Loosen axle nut and separate wheel axle and wheel.

#### **CAUTION**

Do not manipulate brake lever after you remove wheel as it will make wheel assembling difficult

#### [FRONT WHEEL]

Assemble in the opposite order of disassembling.  
Prior to assembling, match the depressed part ( ) of the speedometer gear-box with the projected part of the left front fork.

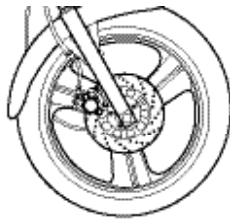
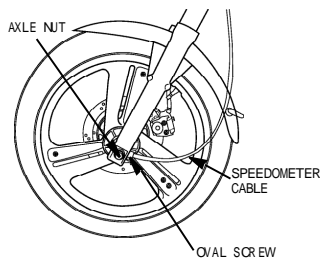

#### [FRONT AXLE NUT TORQUE 6.0KG-M]

After assembling, operate brake for a number of times and see if wheel is turning smoothly without getting interruption.

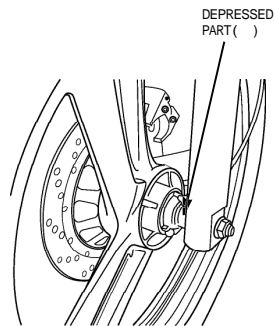

### REAR WHEEL

#### [REAR WHEEL REMOVAL]

Set vehicle on main stand in upright position on level ground.  
 Unscrew the left and right side lock nuts and loosen adjuster.  
 Loosen the rear brake joint nut and remove brake rod from the brake arm.  
 Unscrew axle nut and separate wheel axle and rear wheel.  
 Assemble in the opposite order of disassembling. When assembling, match the depressed part of the brake panel to the projected part of the right side swing arm.

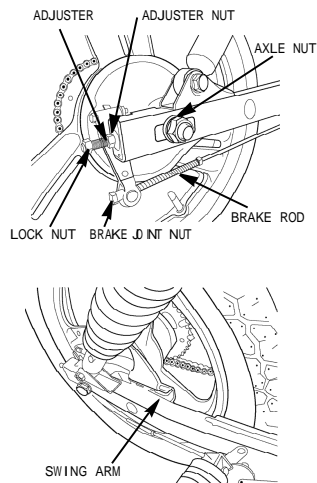

**REAR AXLE NUT TORQUE : 7.0kg-m**  
 After assemble, adjust the rear brake and drive chain free play.(10~20mm)

### SIDE STAND

Erect main stand and place vehicle in upright position on level ground.  
 Check side stand spring for signs of damage and lubrication state on joints.

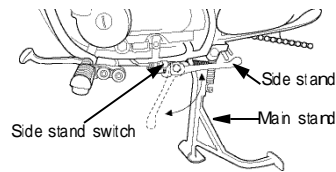

If the side stand put-down, engine will stop directly.

### SPARK PLUG

If electrode is stained or plug gap is not right, satisfactory spark is not produced. Clean and make adjustment.

Remove spark plug cap.  
Clean around the plug.

Using a plug wrench, remove plug.  
Clean plug with plug cleaner.  
Check electrode for wear and corrosion. If the center of electrode became round, replace the electrode.  
Measure the spark plug gap using a feeler gauge.

**PLUG GAP: 0.8-0.9mm**

Tighten with hands until the plug washer touches cylinder head.

**STANDARD PLUG: CR8EH-9**

If new plug is installed, turn 1/2 and tighten using a plug wrench.  
If plug is reused, turn 1/3~1/4 and tighten

**CAUTION**

If the plug of different maker or different heat value is used, it causes unsatisfactory engine starting, inadequate engine revolution and output deterioration.

The spark plug must be securely tightened. An improperly tightened plug can become very hot and possibly damage the engine.

To install a spark plug, turn it in as far as possible with your fingers, then tighten it with a wrench. Do not overtighten or cross thread the spark plug or the aluminum threads of the cylinder head will be damaged. Do not allow contaminants to enter the engine through the spark plug hole when the plug is removed.

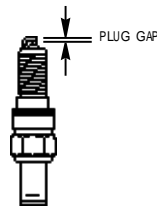

#### <DEALING WITH POOR STARTING>

When the starter doesn't work during driving in winter times or in a repeated short distance, use the suitable spark plug for this driving condition.

Poor starting may happen when nonstop driving in low speed, even though we produce standard plug.

In case starter isn't working well in driving repeatedly in a short distance or in an area with many traffic signals, use the CR7EH-9 plug instead of standard plug CR8EH-9



### FUSE REPLACEMENT

Turn off main switch and check fuse for sign of cut.

Remove the four flange bolts, and take off the right lower cover.

Fuse is installed inside fuse holder located near battery.

To separate fuse, open fuse holder, hold both ends of fuse cord and pull up, and pull out the fuse connector crosswise.

If the newly replaced fuse is burned again soon, it is an indication of trouble.

#### ⚠ WARNING

Never use a fuse with a different rating from that specified. Serious damage to the electrical system or a fire may result, causing a dangerous loss of lights or engine power.

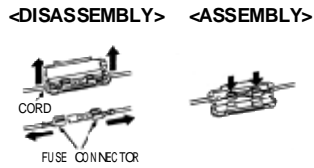
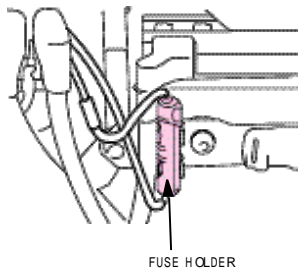

#### ⚠ CAUTION

Turn the ignition switch OFF before checking or replacing fuse to prevent accidental short-circuiting.

When disassemble fuse, make sure that fuse holder isn't separated.

After assembling fuse in the part of connector, check if fuse moves easily to a line. If fuse moves easily, it may cause an accident at heating.

When replacing any of the electrical parts (lights and gauges), be sure to replace them with the recommended parts. Using different parts can lead to the fuses burning out or damage to the battery.

When washing the motorcycle take special care not to allow to be splashed in the area of the fuse.

**CABLE RUBBER PART**

A rubber part is assembled on the cable to protect the inner cable. Make sure that this part is placed firmly around the correct part of the cable. When washing the car, do not directly spray water on to the rubber part is dirty, use a dry cloth to clean this area.

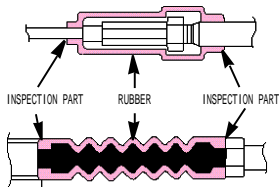

**CAUTION**

Infiltration of the foreign materials or water caused by damage of lever (disengagement, tearing, etc.) may cause freezing in winter season resulting in faulty operation, sudden acceleration and braking force decrease. If any damage is found, replace with the new one immediately.

**CLEANING**

Clean your motorcycle regularly to protect the surface finishes and inspect for damage, wear, and oil, coolant or brake fluid leakage.

**CAUTION**

Make sure to stop the engine prior to car washing. High pressure water (or air) can damage certain parts of the motorcycle. Be careful not to allow water to enter the muffler during the washing. Water inside the muffler may cause an improper engine starting or rust occurrence. Do not let water get inside the braking system during the washing, as water inside the brake system may weaken the braking power. Upon completion of washing, select a safe place where there is no traffic obstruction, and start the vehicle. Lightly apply the brake while driving at a slow speed and check the braking power. If the braking power has been weakened, apply brake lightly while driving at a slow speed to dry up the brake system.

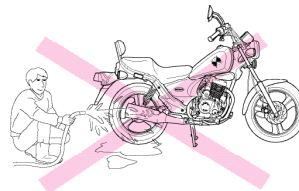

1. After cleaning, rinse the motorcycle thoroughly with plenty of clean water. Strong detergent residue can corrode alloy parts.
2. Dry the motorcycle, start the engine, and let it run for several minutes.
3. Test the brakes before riding the motorcycle. Several applications may be necessary to restore normal braking performance.
4. Lubricate the drive chain immediately after washing and drying the motorcycle.

**WARNING**

Braking efficiency may be temporarily impaired immediately after washing the vehicle. Anticipate longer stopping distance to avoid a possible accident.

### STORAGE GUIDE

Extended storage, such as for winter, requires that you take certain steps to reduce the effects of deterioration from non-use of the motorcycle.

In addition, necessary repairs should be made BEFORE storing the motorcycle; otherwise, these repairs may be forgotten by the time the motorcycle is removed from storage.

#### <STORAGE>

Change the engine oil and filter.

Empty the fuel tank into an approved gasoline container using a commercially available hand siphon or an equivalent method.

If storage will last more than one month, carburetor draining is very important, to assure proper performance after storage.

#### CAUTION

Gasoline is extremely flammable and is explosive under certain conditions. Perform this operation in a well-ventilated area with the engine stopped. Do not smoke or allow flames or sparks in the area where gasoline is drained or stored and where the fuel tank is refueled.

Remove the battery. Store in an area protected from freezing temperatures and direct sunlight. Slow charge the battery once a month.

Wash and dry the motorcycle. Wax all painted surfaces.

Inflate the tires to their recommended pressures. Place the motorcycle on blocks to raise both tires off the ground. Cover the motorcycle (don't use plastic or other coated materials) and store in an unheated area, free of dampness with a minimum of daily temperature variation. Do not store the motorcycle in direct sunlight.

#### <REMOVAL FROM STORAGE>

Uncover and clean the motorcycle.

Charge the battery as required. Install the battery.

Perform all Self Inspections Before Operation checks (page 21).

Test ride the motorcycle at low speeds in a safe riding area away from traffic.

## SAFE DRIVING

### PREPARATION BEFORE DRIVING

- Performing daily inspection
- Putting on the protective gears (Helmet, glove, goggles, etc.)
- Bringing the driver's licence
- Determinating the path to the desired destination

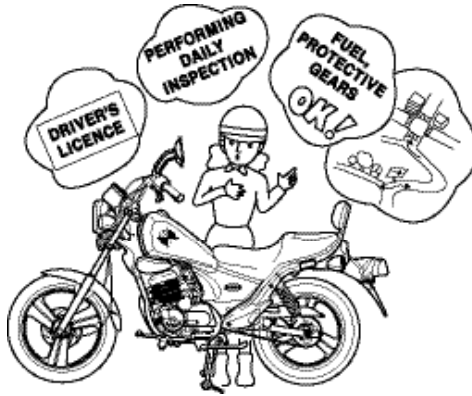

---

**PRECAUTION WHEN DRIVING**

Secure the safe distance.  
Drive protectively.  
Do not obstruct the traffic.  
Do not drive on the pedestrian way or walkway.  
Drive on the left driveway when passing away.  
Make sure that you can apply the brake anytime.  
Always apply the brake when stopping temporarily.  
Do not drive excessively long distance and take enough break.

If any abnormality is found, stop driving and contact service center to inspect the vehicle.  
Restart the vehicle after 2~3 min when it is turned over.  
Always turn on the headlight at night.

## DRIVING METHOD

### DRIVING POSITION

The appropriate driving position is the most important thing to driving safely.

Eyes : Look at the front direction widely.

Shoulders : Relieve the tension.

Arms : Relieve the tension and bend arms to inside and let them act as the spring.

Hands : Grip the handle the position away from the inside end of the handle with distance of one finger to facilitate the operation of the switch and lever.

Wrist : Keep the state to act freely without applying excessive force to the shoulder and arms.

Knees : Press the fuel tank slightly.

Feet : Place the feet to face the front parallel and make the step bar be placed in the center of feet.

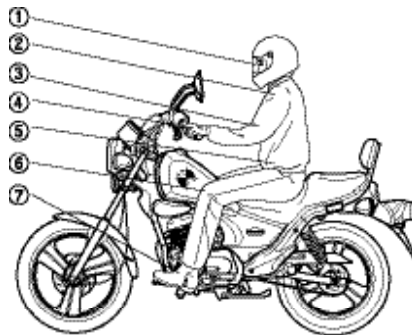

## STARTING

Prior to starting always look around to avoid accident.

Get on the vehicle after pulling back the stand.

Start driving slowly after turning on the winker and releasing the brake while ensuring the safety around the vehicle.

### CAUTION

Return the side stand to its original position, keep driving without doing this may cause turnover accident.

Drive the vehicle only on the driveway. Driving on the walkway can cause accident. Also, if the wheel is transformed when advancing directly to the walkway, the vehicle can be overturned resulting in injury of the driver due to the driving instability.

Overspeed driving on the unpaved road can cause the vehicle to be overturned resulting in injury of the driver due to the driving instability.

Do not drive in the gravel road. If any gravel enters the wheel or engine case, the vehicle can be overturned resulting in injury of the driver.

If possible, do not drive close to the sea or on the road where calcium chloride is treated. The muffler, external parts and welded parts can be corroded rapidly, and also in case of damage of the frame, the vehicle can be overturned resulting in injury of the driver.

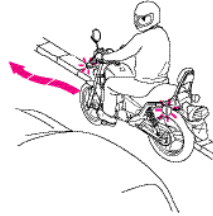

## TURNING METHOD

### PRINCIPLE OF TURNING

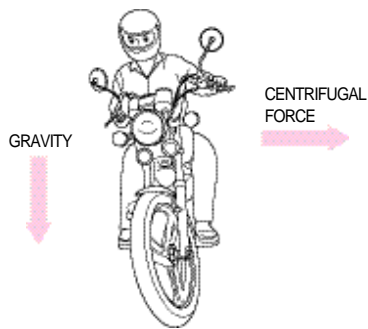

The basic principle of turn is balancing using the centrifugal force which makes vehicle go outside and the gravity which makes vehicle fall inside.

### EFFECT OF SPEED

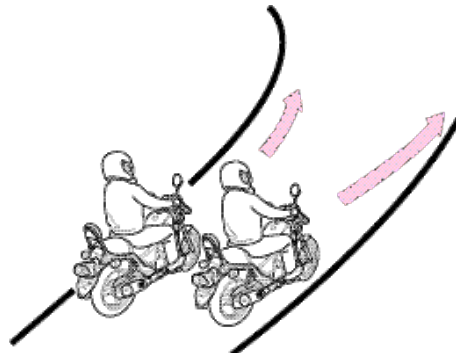

The centrifugal force increases in inverse portion to the radius of a curve and in portion to the square speed. Decelerate prior to entering the curved way to reduce the centrifugal force.



### 3 POSITIONS OF TURNING

The basic principle of turn is balancing using combined force of the centrifugal force and the gravity. All 3 positions require straightening the head and keeping the eyes horizontally.

#### < LEAN-WITH >

This is a turning position with motorcycle and driver in a line. This position is the most natural and exact, so driver must learn it thoroughly.



#### < LEAN-IN >

This is a turning position with driver leaned inside more than motorcycle. This position is adequate to drive on the rained or slippery road because it has best road holding. However, special attention is required because front visual field is poor when driver leans inside more than motorcycle.



**< LEAN-OUT >**

This is a turning position with motorcycle leaned inside more than driver, which is opposite to the lean-in position. With this position, quick turn is well performed and driver can obtain wide front visual field adequate to drive on the rained or slippery road because it has best road holding. However, special attention is required because there is danger of slipping on the bad holding road.

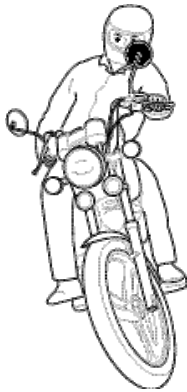

**TURNING METHOD**

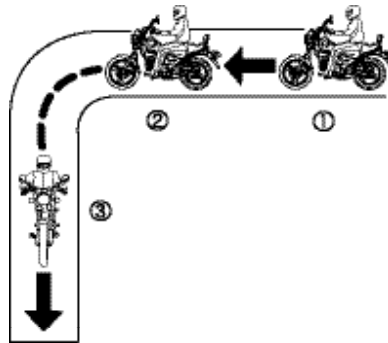

Turn the throttle grip to its original position and decelerate using both front and rear brakes.  
Lean the vehicle toward inside of turn circle while driving slowly at constant speed.  
Accelerate gradually.

**PRECAUTION WHEN TURNING**

Do not drive inside of large truck's turn circle.

**< BLIND SPOTS >**

Blind spots are the sight ranges which cannot be identified by driver and increases in proportion to the width of the motorcycle.

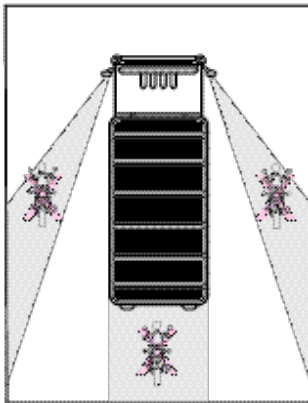

**< DISTANCE BETWEEN THE FRONT AND REAR WHEEL TURN >**

It is distance between path of the front and rear wheel and increases in proportion to the length of the motorcycle.

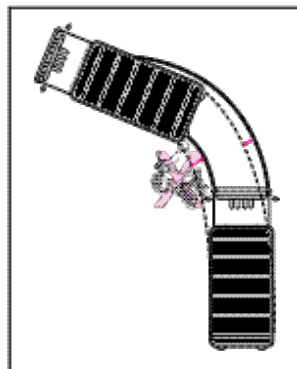

## BRAKING METHOD

### BASIC PRINCIPLE OF BRAKE (FRICTION FORCE)

Vehicle is braked using friction between road surface and tires.

Braking distance increases 1.5 times on wet road and 3 times on icy road because friction force of road surface is decreased.

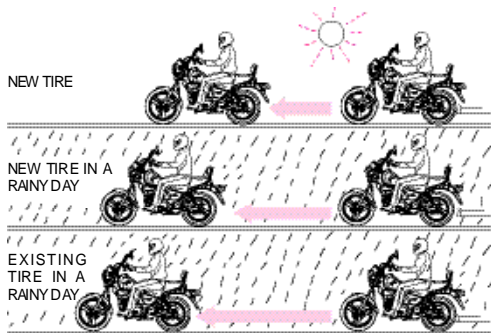

### RESTRAINT OF BRAKE EFFECT (INERTIA)

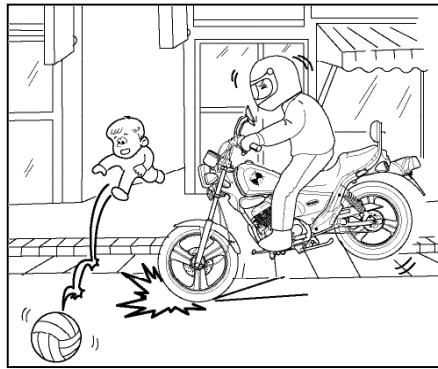

Due to the inertia, vehicle does not stop immediately after applying the brake.

### BRAKING METHOD

Turn the throttle grip to its original position and decelerate using the engine brake.  
Erect the vehicle straight.  
Brake using both front and rear brakes.

### COMPARISON OF BRAKING DISTANCE

· Vehicle speed : 50 km/h



When using both front and rear brakes



When using only front brake



When using only rear brake

### IMPACT WHEN COLLISION

Learn the proper braking method to prevent accident.

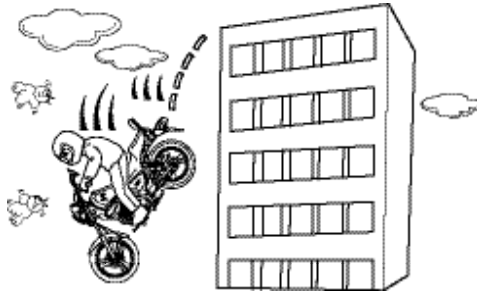

Impact increases in proportion to the speed and weight. The impact when collision to concrete wall at 50 km/h is same as one when falling from the height of 10m.

**WIRING DIAGRAM**

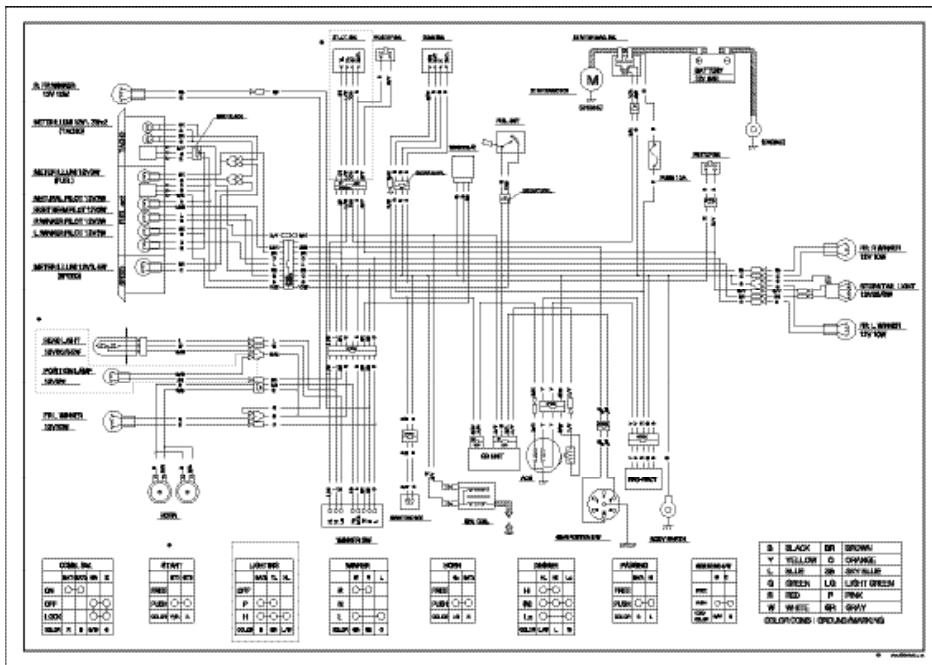

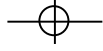



MEMO : \_\_\_\_\_  
\_\_\_\_\_  
\_\_\_\_\_  
\_\_\_\_\_  
\_\_\_\_\_  
\_\_\_\_\_  
\_\_\_\_\_  
\_\_\_\_\_  
\_\_\_\_\_  
\_\_\_\_\_  
\_\_\_\_\_  
\_\_\_\_\_  
\_\_\_\_\_  
\_\_\_\_\_  
\_\_\_\_\_  
\_\_\_\_\_  
\_\_\_\_\_





